

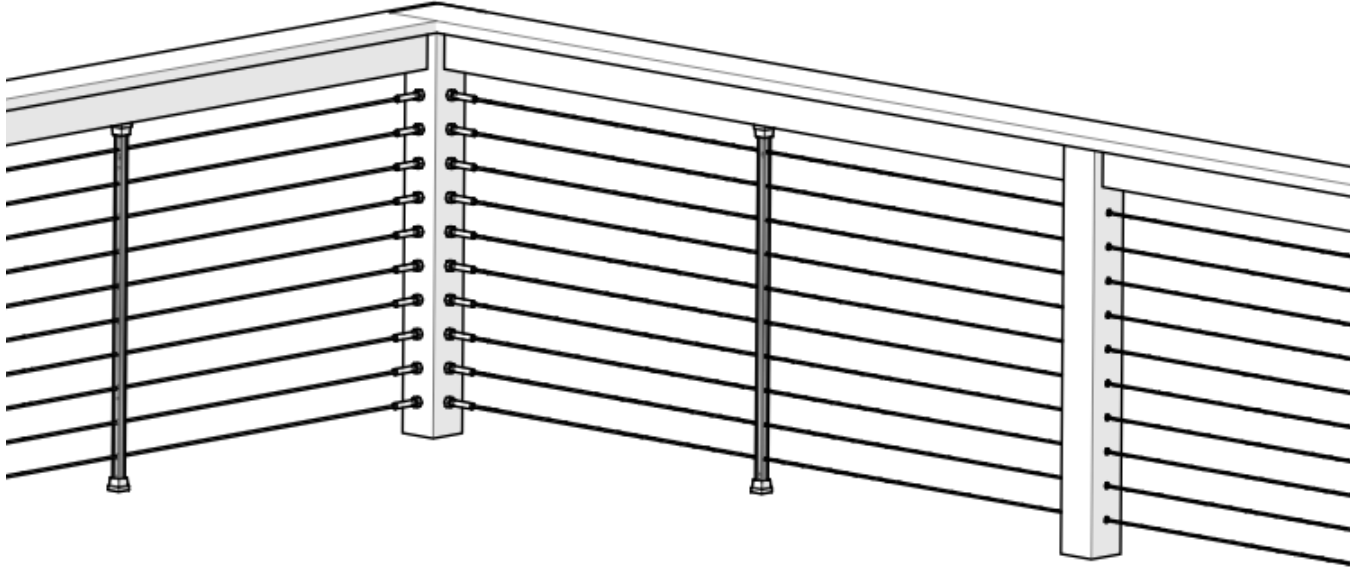

HORIZONTAL WOOD APPLICATION CABLE HARDWARE



Recommended Tools

- Safety Glasses
- Tape Measure & Pencil
- Power Drill / ($\frac{1}{8}$ " , $\frac{5}{16}$ " bits)
- Cable Cutter

● Available from Key-Link

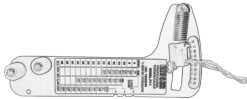

● Tension Gauge
(Optional)

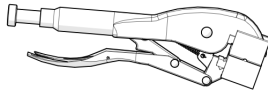

● Cable Vise Grip

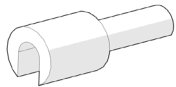

● Cable Release Key



● Cable Cutter

What's Included

- Baluster(s) & Baluster Mount *(optional)*
- Stainless Steel Cable *(optional)*
- Cable Receiver Hardware
- Screws
(Predrilled Posts, Caps, & Trim packaged separate)

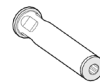

Cable Receiver



Flat Head Screws

Baluster Mount
(optional)



Threaded Base



Threaded Nut



Through Sleeve
(optional)

- *These directions are only a guide and may not address every situation.*
- *Always wear proper safety equipment while assembling and installing.*
- *The installer should obtain all required building permits and follow all installation procedures in accordance with applicable building code requirements.*
- *Key-Link Fencing and Railing Inc. shall not be held liable for improper or unsafe installations.*
- *Applying paint, other than Key-Link's touch up paint, will void your warranty.*
- *To ensure proper coverage by our warranty please visit our website and complete the warranty form and mail to: Key-Link Fencing & Railing, Inc., 150 Orlan Road, New Holland, PA 17557*



WARNING: This product can expose you to chemicals including Quartz (crystalline silica), which is known to the State of California to cause cancer, and Hexavalent Chromium, which is known to the State of California to cause birth defects or other reproductive harm. For more information go to www.P65Warnings.ca.gov.

1 Install Railing Post

Space Posts evenly to fit *application and attach to structural surface. Posts must be properly secured to structural surface, and a structural member must be placed between top of Posts (*reference illustration below*) to ensure proper cable tensioning capability. Ensure Post is installed plumb and level.

*Check your local building codes to determine structural mounting requirements for Post.

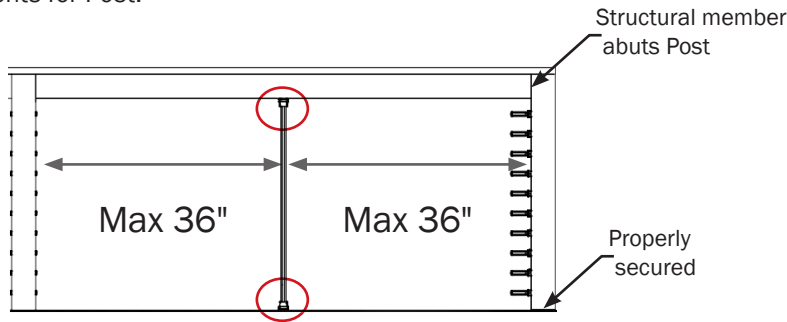

Balusters should be spaced evenly and no more than 36" apart

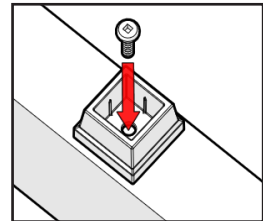

2 Attach Baluster Mount (optional)

Attach a baluster mount centered (*circled*) on the bottom surface of the top rail and another to the deck aligned with the baluster mount on the top rail. Fasten the Baluster to the Mount.

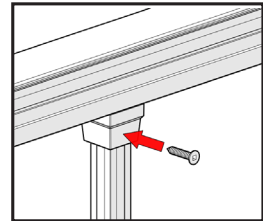

3 Attach Post Receiver

Mark the center of the connecting face of each Post. Then, mark $2\frac{3}{4}$ " from the bottom of the Post & $2\frac{7}{8}$ " consecutively above that; totalling the amount of cables being run.

Attach Threaded Base to face of Post at each interval previously marked.

Attach Post Receiver to Threaded Base using Threaded Nut.

Check to make sure the Lock Jaw housing (*highlighted*) is threaded all the way out to the cap to maximize tensioning capacity.

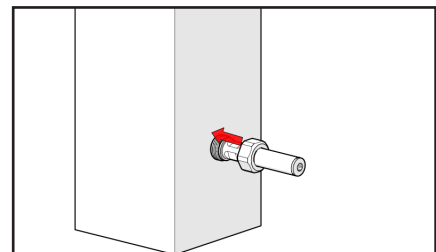
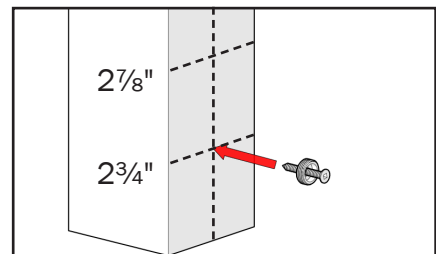
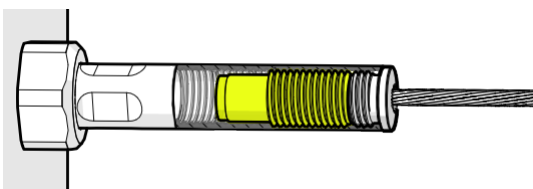

4 Install Cable

Pull the cable taut removing all slack from each section. Cut the cable $1\frac{1}{4}$ " longer than the end of the Post Receiver. When inserting the cable into the Lock Jaws turn it slightly clockwise to avoid fraying the cable and make sure the cable is seated all the way back in the Lock Jaw housing before tensioning the cable. Forcefully pull to ensure a firm connection. (*Considerable force is needed*).

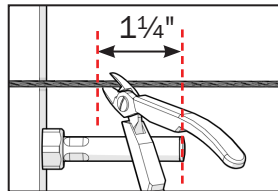

Using a $\frac{7}{16}$ " wrench; rotate counter-clockwise to increase cable tension.

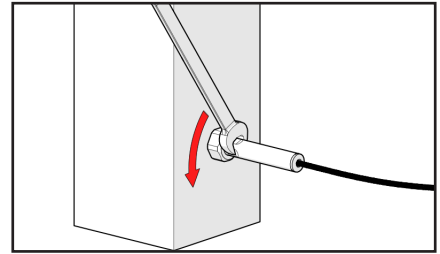
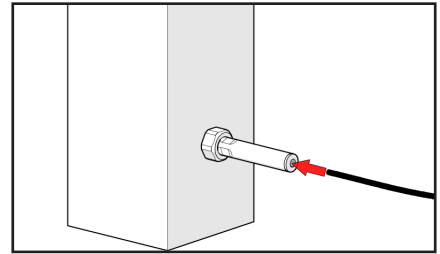

5 Cable Through Hardware (optional)

For Posts where Cable Through Hardware is used. Mark both connecting faces of each Post. Drill a hole (using a $\frac{5}{16}$ " Drill bit) to the center of the Post from each side.

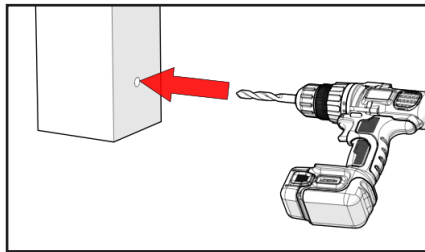

Use a Rubber Mallet to tap Wood Cable Through Sleeves into place on either side of the Post.

Insert Cable through Sleeves.

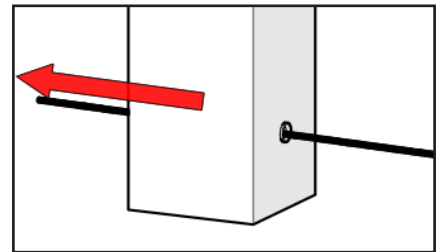
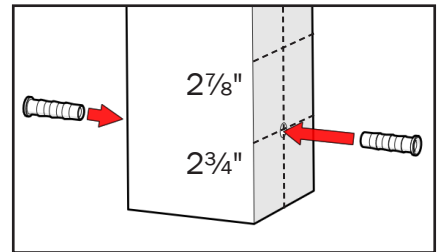

! NOTE: How to Loosen Stuck Jaws

In the event that the jaws of the post receiver become stuck.

Insert an Allen Wrench into the open end of the cable receiver, and press until you can feel the internal spring release.

Cable Release Key

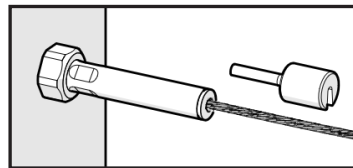

To use the **Cable Release Key**, slide it over the cable into the receiver, and push to release the cable. For use before the cable is fully tightened.

6

Stair Rail

To determine placement of the first Receiver; use a straight edge laid flat on the nose of the stairs, and measure off the surface to the first mark on the Level Post, and translate that measurement to each Post/ Baluster.

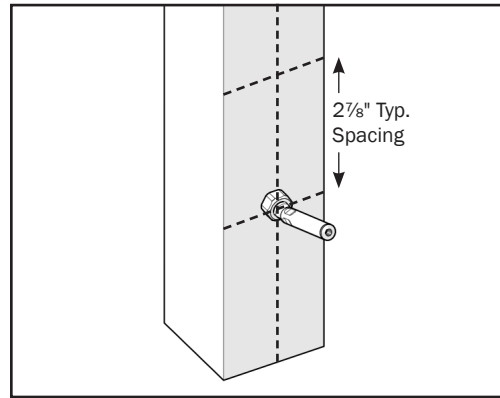
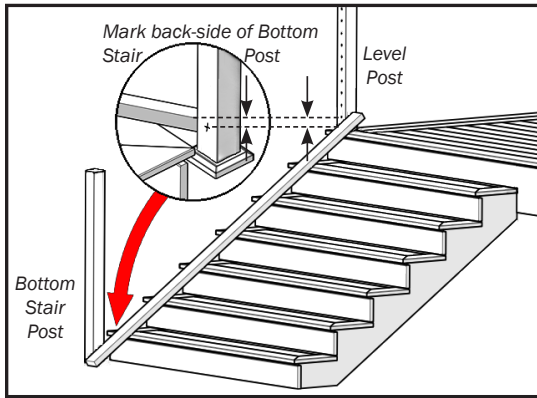

Use typical spacing (2 7/8") to mark each additional hole on back-side of the Bottom Stair Post, and drill a 1/8" pilot hole at each mark.

Note: On a Line Post, or Baluster; 3/16" holes should be drilled at the appropriate stair angle.



150 Orlan Road • New Holland, PA 17557

KeyLinkOnline.com